

R107 COMPLIANT











Roof Hatches



Manual Roof Hatches

R107 COMPLIANT

*Botole Manuali
Trappes de Toit Manuelles
Manuelle Dachluken*









	 DOUBLE ABS	 GLASS	 DARKENED GLASS	 DOUBLE GLASS	 PMMA	 5mm ABS
	/	BT.8.4	BT.8.5	BT.8.7	/	/
	BT.8.1	BT.8.2	BT.8.3	BT.8.8	BT.8.9	BT.8.6



Semi-Electric Roof Hatches

R107 COMPLIANT

*Botole Semielettriche
Trappes de Toit Semi-Electriques
Halb Elektrische Dachluken*

	 DOUBLE ABS		 GLASS		 DARKENED GLASS		 DOUBLE GLASS		 PMMA		 5mm ABS	
	12 V	24 V	12 V	24 V	12 V	24 V	12 V	24 V	12 V	24 V	12 V	24 V
	/	/	BT.9.4	BT.9.12	BT.9.5	BT.9.13	BT.9.17	BT.9.18	/	/	/	/
	BT.9.1	BT.9.9	BT.9.2	BT.9.10	BT.9.3	BT.9.11	BT.9.8	BT.9.16	BT.9.14	BT.9.15	BT.9.6	BT.9.7

PLASTIC VERSION

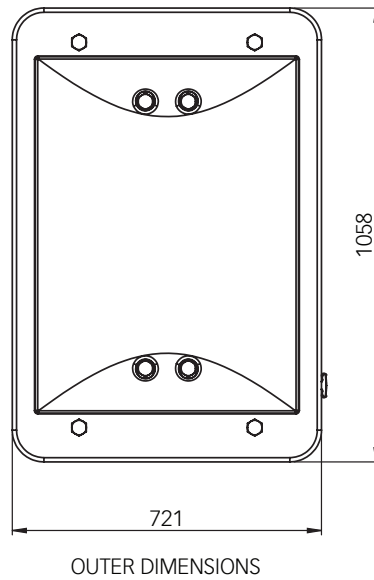
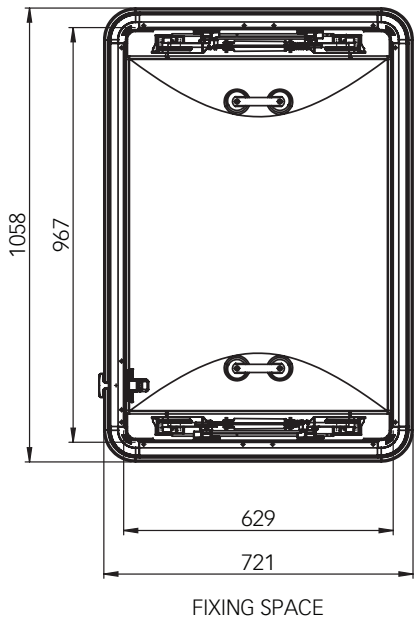
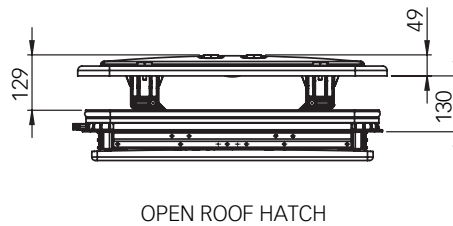
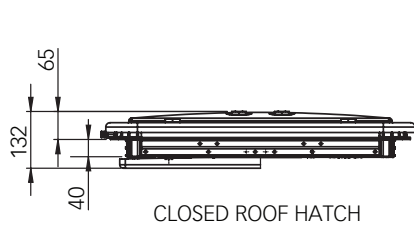

GLASS VERSION

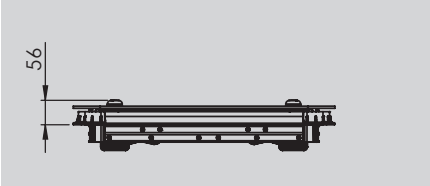

Roof Hatches



Electric Roof Hatches
Botole Elettriche
Trappes de Toit Electriques
Elektrische Dachluken

R107 COMPLIANT



DOUBLE ABS		GLASS		DARKENED GLASS		DOUBLE GLASS		PMMA		5mm ABS	
12 V	24 V	12 V	24 V	12 V	24 V	12 V	24 V	12 V	24 V	12 V	24 V
/	/	BT.10.4	BT.10.12	BT.10.5	BT.10.13	BT.10.17	BT.10.18	/	/	/	/
BT.10.1	BT.10.9	BT.10.2	BT.10.10	BT.10.3	BT.10.11	BT.10.8	BT.10.16	BT.10.14	BT.10.15	BT.10.6	BT.10.7

